

# FLIGHT-T54

Proiettore  
da 4600 lm a 30000 lm



ILLUMINAZIONE

**Palazzoli**  
LUCE D'AUTORE

# FLIGHT-T54

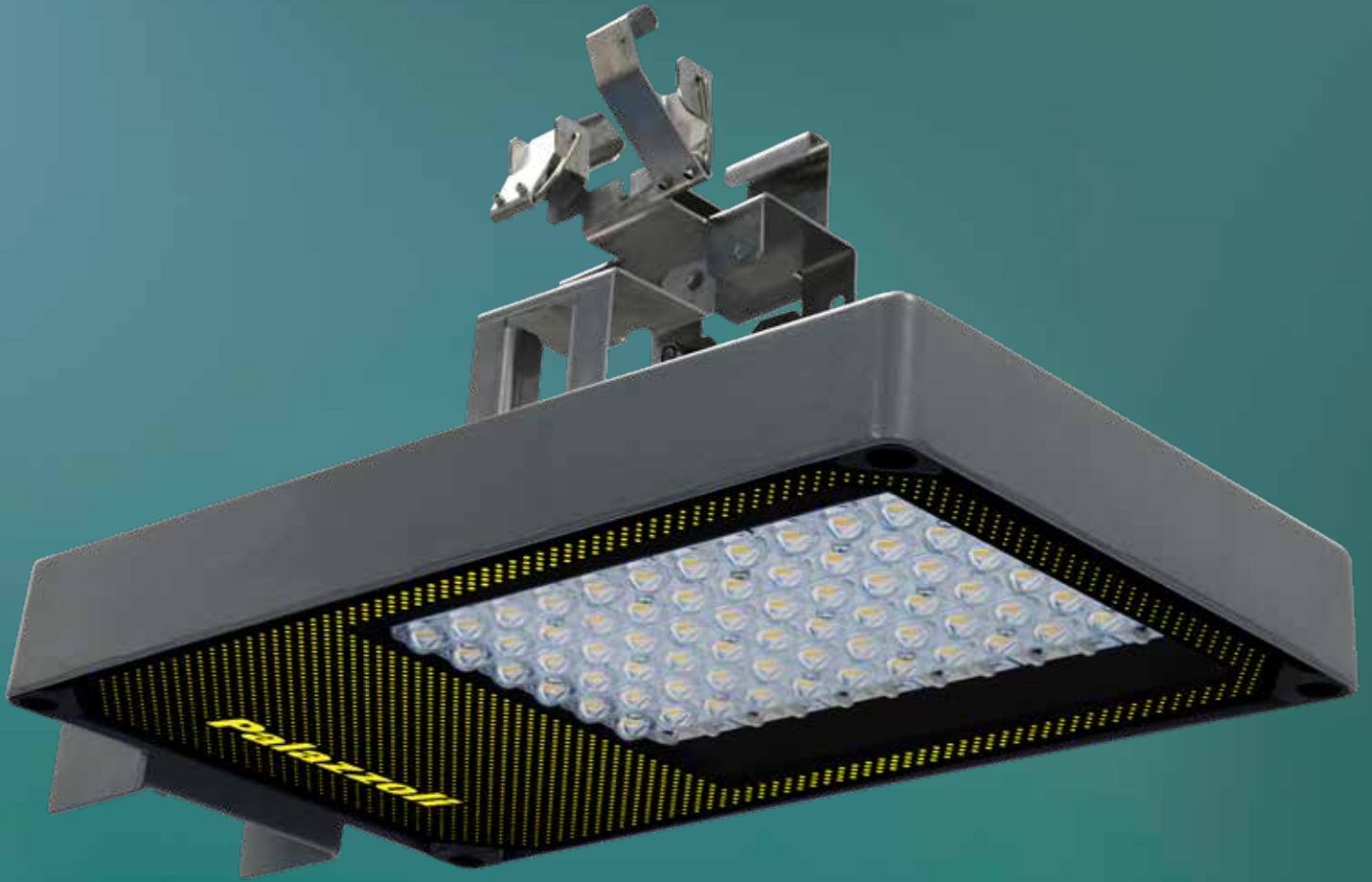

## La serie

---

Nuovi apparecchi per l'illuminazione di gallerie dotati di un corpo realizzato da pressofusione in lega di alluminio EN44300, con un bassissimo contenuto di rame e un trattamento anticorrosione per garantire la massima resistenza. Il gruppo elettronico di questi apparecchi è dotato di moduli LED proprietari, protetti da cortocircuiti, sovratensioni e sovratemperature. La gamma FLIGHT-T54 è disponibile con riflettori in alluminio purissimo al 99,9% oppure con lenti in PMMA con una trasparenza superiore al 95%. Questa flessibilità consente alla gamma di offrire un'ampia scelta di ottiche. Questi apparecchi sono dotati di un diffusore in vetro piano extrachiario, spesso 4 mm, temperato e resistente agli urti e ai raggi UV. Per quanto riguarda l'installazione, FLIGHT-T54 può essere accessoriata con staffe che consentono un aggancio rapido alla canalina.

Infine, è importante sottolineare che FLIGHT-T54 può essere controllata tramite sistemi ad onde radio, onde convogliate o DALI.



### FLIGHT T-54 S

---



### FLIGHT T-54 M

---

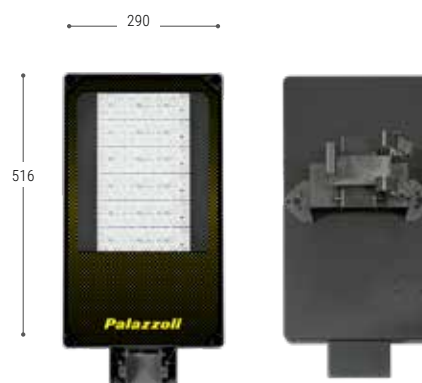

## La gamma

**FLIGHT-T54 TAGLIA S**

Proiettori

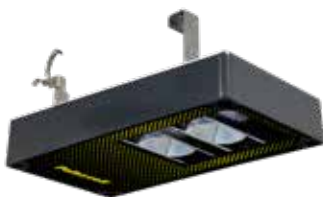
**FLIGHT-T54 TAGLIA M**

Proiettori



Flusso nominale	da 5520 lm a 12044 lm	da 17820 lm a 35112 lm
Flusso in uscita	da 4600 lm a 10037 lm	da 14850 lm a 29260 lm
Potenza	fino a 66 W	fino a 220 W
Efficienza	fino a 165 lm/W	fino a 135 lm/W
Sistemi di controllo	On - off (a richiesta dimmerabili tramite diversi standard)	On - off (a richiesta dimmerabili tramite diversi standard)
Versioni	Standard	Standard
Ottiche	Permanente asimmetrica PA5 Permanente asimmetrica STR-ST Permanente asimmetrica STR-AM	Rinforzo asimmetrico diffondente 50° Rinforzo asimmetrico concentrante 55° Rinforzo simmetrico 65°

**FOS - FLIGHT Optical System**

FOS (FLIGHT Optical System) è il sistema di Palazzoli che permette la regolazione dell'ottica fino a 5 posizioni, anche a prodotto già installato, per modificare l'emissione luminosa anteriore e laterale. Questo consente di migliorare l'uniformità tra i pali o adattare l'ottica se il flusso luminoso abbaglia fuori dalla strada. Tramite la regolazione delle ottiche è inoltre possibile realizzare anche l'ottica per l'illuminazione delle piste ciclabili.

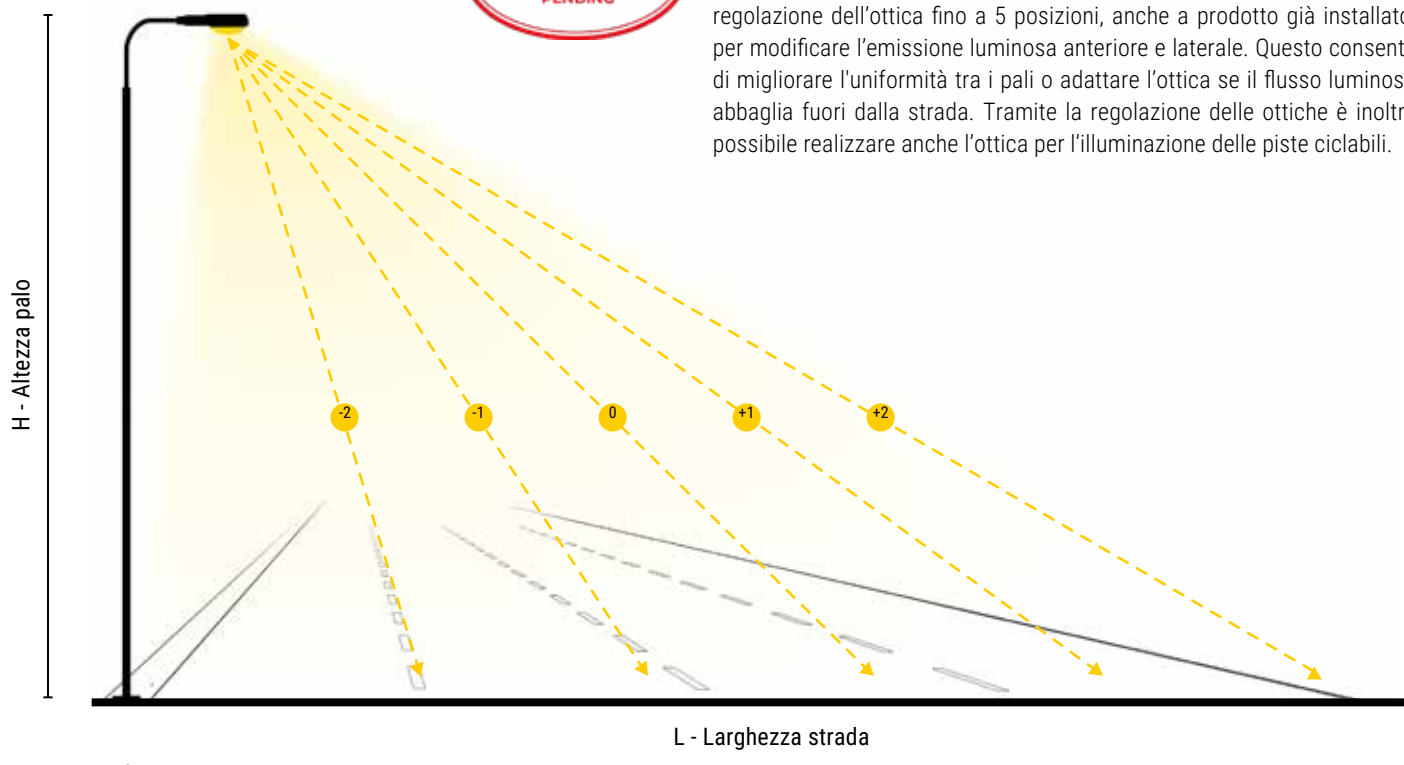

La gamma FLIGHT con riflettori in alluminio purissimo 99,9% con rivestimento PVD in argento.



La gamma FLIGHT con lenti in PMMA antiinvecchiamento resistente ai raggi UV con rendimento >90% e trasparenza >95%.



## Le ottiche

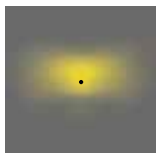
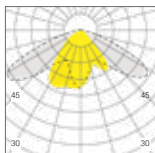

Permanente asimmetrica PA5

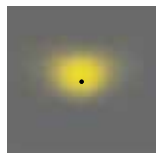
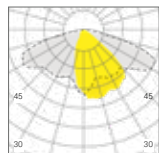

Permanente asimmetrica STR-ST

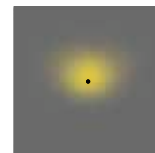
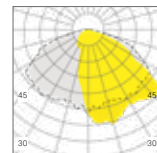

Permanente asimmetrica STR-AM

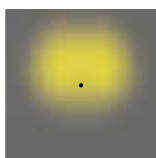
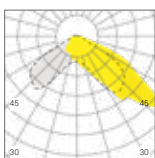

Rinforzo asimmetrico diffondente 50°

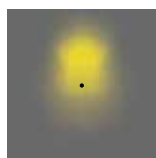
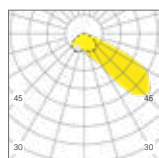

Rinforzo asimmetrico concentrante 55°

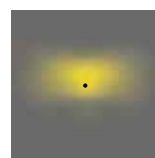
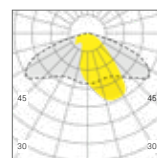

Rinforzo simmetrico 65°



# Tunnel

Gallerie stradali  
e autostradali



# FLIGHT-T54



Materiale corpo	<b>Lega di alluminio a basso contenuto di rame (EN 44300)</b>
Trattamento superficiale	<b>Passivazione a fluorozirconatura</b>
Finitura superficiale	<b>Vernice poliesteri atossica polimerizzata a caldo</b>
Colore	<b>Grigio RAL 7011</b>
Materiale diffusore	<b>Vetro temperato extrachiaro</b>
Grado di protezione	<b>IP66 secondo IEC 60079-0 e 60598-1</b>
Resistenza agli urti	<b>IK08 secondo IEC 62262</b>
Classe di corrosione	<b>C5-M / C4-H (ISO 9223)</b>
Sistema di fissaggio	<b>Predisposto per supporti di aggancio alla canale</b>
Temperatura ambiente di esercizio	<b>-30 °C - +40°C</b>
Temperatura ambiente di stoccaggio	<b>-40°C - +70°C</b>
Efficienza reale apparecchio	<b>Fino a 165 lm/W</b>
Temperatura di colore	<b>4000K</b>
Caratteristiche ottica	<b>Taglia S con riflettore in alluminio 99,9% ad alta efficienza Taglia M con lenti PMMA anti invecchiamento e resistente ai raggi UV con rendimento &gt; 90% e trasparenza &gt; 95%</b>
Indice di resa cromatica	<b>CRI≥70 secondo EN 62717</b>
Consistenza colore	<b>4 step di MacAdam</b>
Rischio fotobiologico	<b>RG0-Exempt Group (EN 62471)</b>
Flicker residuo	<b>&lt;1%</b>
Mantenimento flusso luminoso	<b>L80 B10 150.000 h Tq=+25°C</b>
Classe di isolamento	<b>II</b>
Tensione di alimentazione	<b>220V-240V 50/60Hz</b>
Protezione alle sovratensioni	<b>10 kV modo comune e modo differenziale secondo EN61000-4-5</b>
Fattore di potenza	<b>&gt;0,95</b>
Tipo alimentazione	<b>Spina 16A 2P IP67 IEC EN 60309-1/-2</b>



**GARANZIA**  
2 ANNI ESTENDIBILE A 10 ANNI



## DIRETTIVE

2014/30/UE (EMC)  
2014/35/UE (LVD)  
2011/65/UE (RoHS)  
2012/19/UE (RAEE)  
2009/125/CE (ERP)  
Reg. UE 2019/2020 (EcoDesign)

## NORME DI PRODOTTO

EN 55015  
EN 60598-1  
EN 60598-2-1  
EN 60598-2-3  
EN 60598-2-5  
EN 61000-3-2  
EN 61000-3-3  
EN 61547  
EN 62311  
EN 62493  
EN 62471  
IEC TR 62778  
EN 63000

Si possono realizzare versioni speciali per la telegestione dell'impianto.



# FLIGHT-T54 | taglia S

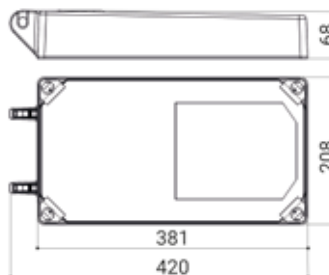

Flicker  
<1%

Classe  
II

IP66

IK08

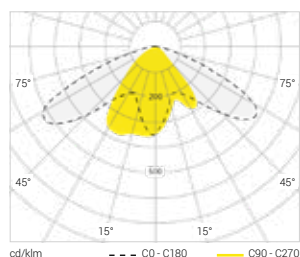

## Ottica permanente asimmetrica PA5

In dotazione: alimentazione con spina 16A 2P IP67 IEC EN 60309-1/-2 con cavo FTG180M16 da 1,5 mm<sup>2</sup>.  
I valori indicati di flusso e potenze presentano una tolleranza di +/- 7 %.

### Permanente



N. LED	Potenza (W)	Flusso nominale (lm) Tj=25°C	Flusso in uscita (lm) Tq=25°C	Diffusore	Efficienza (lm/W)	Versione	Peso (Kg)	Codice
14	38	6790	5658	Vetro	150	On-off	5,00	<b>802192</b>
28	28	5520	4600	Vetro	165	On-off	5,00	<b>802232</b>
28	44	8290	6908	Vetro	156	On-off	5,00	<b>802252</b>
28	66	12044	10037	Vetro	153	On-off	5,00	<b>802282</b>

FLIGHT-T54 | taglia S

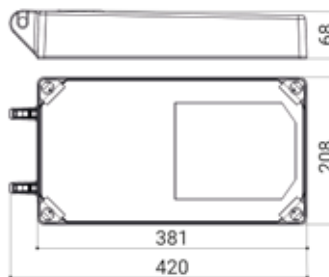

Flicker  
<1%

Classe  
II

IP66

IK08

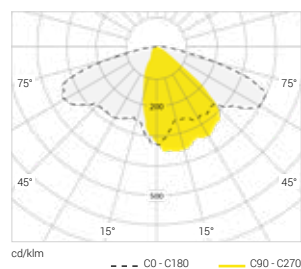

Ottica permanente asimmetrica STR-ST

In dotazione: alimentazione con spina 16A 2P IP67 IEC EN 60309-1/-2 con cavo FTG180M16 da 1,5 mm<sup>2</sup>.

FOS a pag. 4.

I valori indicati di flusso e potenze presentano una tolleranza di +/- 7 %.

Permanente



N. LED	Potenza (W)	Flusso nominale (lm) Tj=25°C	Flusso in uscita (lm) Tq=25°C	Diffusore	Efficienza (lm/W)	Versione	Peso (Kg)	Codice
14	38	6790	5658	Vetro	150	On-off	5,00	<b>802191</b>
28	28	5520	4600	Vetro	165	On-off	5,00	<b>802231</b>
28	44	8290	6908	Vetro	156	On-off	5,00	<b>802251</b>
28	66	12044	10037	Vetro	153	On-off	5,00	<b>802281</b>

# FLIGHT-T54 | TAGLIA S

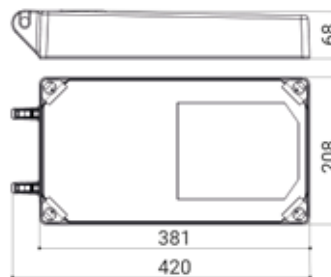

Flicker  
<1%

Classe  
II

IP66

IK08

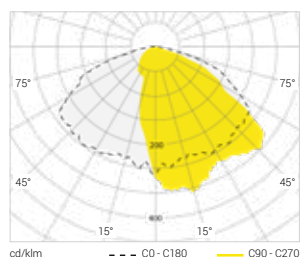

## Ottica permanente asimmetrica STR-AM

In dotazione: alimentazione con spina 16A 2P IP67 IEC EN 60309-1/-2 con cavo FTG180M16 da 1,5 mm<sup>2</sup>.

FOS a pag. 4.

I valori indicati di flusso e potenze presentano una tolleranza di +/- 7 %.

### Permanente



N. LED	Potenza (W)	Flusso nominale (lm) Tj=25°C	Flusso in uscita (lm) Tq=25°C	Diffusore	Efficienza (lm/W)	Versione	Peso (Kg)	Codice
14	38	6790	5658	Vetro	150	On-off	5,00	<b>802190</b>
28	28	5520	4600	Vetro	165	On-off	5,00	<b>802230</b>
28	44	8290	6908	Vetro	156	On-off	5,00	<b>802250</b>
28	66	12044	10037	Vetro	153	On-off	5,00	<b>802280</b>

# FLIGHT-T54 | TAGLIA M

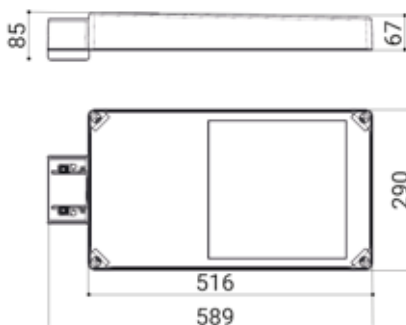

Flicker  
<1%

Classe  
II

IP66

IK08

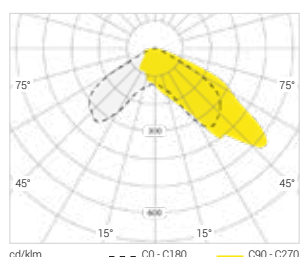

## Ottica rinforzo asimmetrico diffondente 50°

In dotazione: alimentazione con spina 16A 2P IP67 IEC EN 60309-1/-2 con cavo FTG180M16 da 1,5 mm<sup>2</sup>.  
Lenti in PMMA.

I valori indicati di flusso e potenze presentano una tolleranza di +/- 7 %.

### Rinforzo



N. LED	Potenza (W)	Flusso nominale (lm) Tj=25°C	Flusso in uscita (lm) Tq=25°C	Diffusore	Efficienza (lm/W)	Versione	Peso (Kg)	Codice
48	110	17820	14850	Vetro	135	On-off	7,50	<b>802317</b>
48	146	23652	19710	Vetro	135	On-off	7,50	<b>802417</b>
60	183	29426	24522	Vetro	134	On-off	7,50	<b>802517</b>
72	220	35112	29260	Vetro	133	On-off	7,50	<b>802617</b>

# FLIGHT-T54 | TAGLIA M

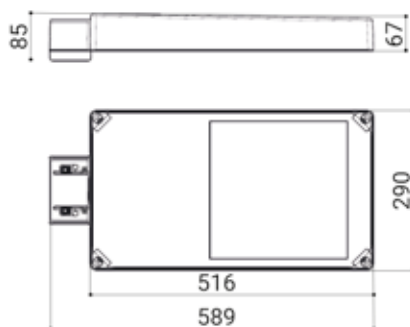

Flicker  
<1%

Classe  
II

IP66

IK08

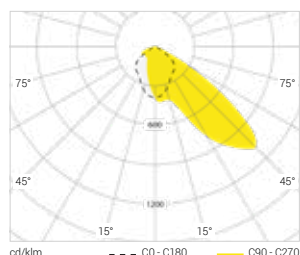

## Ottica rinforzo asimmetrico concentrante 55°

In dotazione: alimentazione con spina 16A 2P IP67 IEC EN 60309-1/-2 con cavo FTG180M16 da 1,5 mm<sup>2</sup>.

Lenti in PMMA.

I valori indicati di flusso e potenze presentano una tolleranza di +/- 7 %.

### Rinforzo



N. LED	Potenza (W)	Flusso nominale (lm) Tj=25°C	Flusso in uscita (lm) Tq=25°C	Diffusore	Efficienza (lm/W)	Versione	Peso (Kg)	Codice
48	110	17820	14850	Vetro	135	On-off	7,50	<b>802315</b>
48	146	23652	19710	Vetro	135	On-off	7,50	<b>802415</b>
60	183	29426	24522	Vetro	134	On-off	7,50	<b>802515</b>
72	220	35112	29260	Vetro	133	On-off	7,50	<b>802615</b>

# FLIGHT-T54 | taglia M

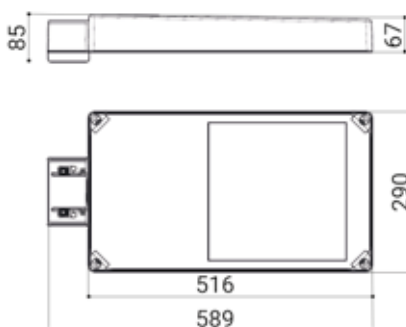

Flicker  
<1%

Classe  
II

IP66

IK08

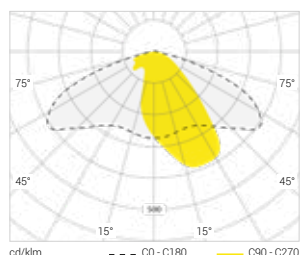

## Ottica rinforzo simmetrico 65°

In dotazione: alimentazione con spina 16A 2P IP67 IEC EN 60309-1/-2 con cavo FTG180M16 da 1,5 mm<sup>2</sup>.

Lenti in PMMA.

I valori indicati di flusso e potenze presentano una tolleranza di +/- 7 %.

### Rinforzo



N. LED	Potenza (W)	Flusso nominale (lm) Tj=25°C	Flusso in uscita (lm) Tq=25°C	Diffusore	Efficienza (lm/W)	Versione	Peso (Kg)	Codice
48	110	17820	14850	Vetro	135	On-off	7,50	<b>802314</b>
48	146	23652	19710	Vetro	135	On-off	7,50	<b>802414</b>
60	183	29426	24522	Vetro	134	On-off	7,50	<b>802514</b>
72	220	35112	29260	Vetro	133	On-off	7,50	<b>802614</b>

# Accessori FLIGHT-T54



FLIGHT- T54 provvisto di **supporti ad aggancio rapido alla canalina**

## Staffe per aggancio rapido alla canalina taglia S



Materiale:  
Acciaio INOX AISI 304

Dimensioni canalina	Codice
100 x 75	
200 x 75	<b>802900</b>
300 x 75	
100x 100	
200x 100	<b>802901</b>
300x 100	

## Staffe per aggancio rapido alla canalina taglia M



Materiale:  
Acciaio INOX AISI 304

Dimensioni canalina	Codice
100 x 75	
200 x 75	<b>802903</b>
300 x 75	
100x 100	
200x 100	<b>802904</b>
300x 100	



Chiarezza della funzione  
Semplicità del progetto  
Qualità della manifattura  
Eccellenza del servizio



Palazzoli S.p.A.  
Via F. Palazzoli, 31 - 25128 Brescia - Italy  
Tel. +39 030 2015.1  
[palazzoli.com](http://palazzoli.com)



**Palazzoli**  
LUCE D'AUTORE